

Integrity Instruments

P.O. Box 451
Pine River Minnesota
56474 USA

Order Phone 800-450-2001
Fax Phone 218-587-3414
Tech Phone 218-587-3120

<http://www.integrityusa.com>

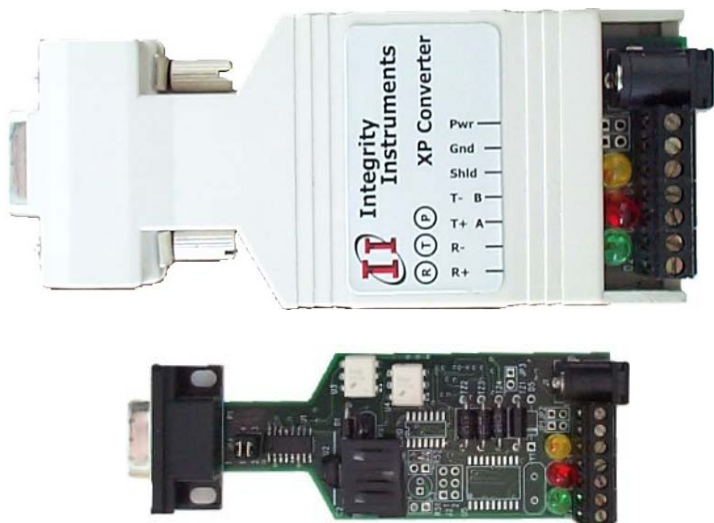

XP422-9A
ISOLATED XP422-9I
RS-232 to RS-422

Converter

Integrity Instruments XP422-9A/I User Manual

Performance Characteristics		
Operating Temperature Range	-40°C to +85°C (-40F to +185F)	
DC input voltage min. (+V)	7.5 Vdc	
DC input voltage maximum. (+V)	24 Vdc	
DC input current nominal (+V) XP422-9A	45 ma	
DC input current nominal (+V) XP422-9I	90 ma	
DC input current max. (+V)	250 ma	
ESD static discharge (A/B)	1500 V	
Baud Rate maximum	115.2 Kbps	
Baud Rate minimum	600 bps	
Number of RS-422 nodes	Point to Point (SEE NOTE)	
Maximum cable length	4000 feet +	
Termination resistance	120 ohms	
Isolation voltage (XP422-9I ONLY)	3,000 volts	
JUMPER SETTINGS		
JUMPER NUMBER	FUNCTION	DEFAULT
JP4 JP5	DTE OR DCE	DCE (ORIENTATION)

NOTE:

RS-422 is point to point, that is point A to point B only. RS-422 multi-drop is really RS-485 4 wire.

DB9 Pinning

RS-232 TxD transmit (output):	DB9 pin 3
RS-232 RxD receive (input):	DB9 pin 2
RS-232 Ground	DB9 pin 5

LED Operation

The **XP422-9A/I** provides a power status and signal LEDs to aid in cabling problems and general operation. Since the signal LEDs are powered only when data is present, they may be illuminated for somewhat brief periods.

POWER YELLOW LED :	Power to unit when on
SIGNAL RED LED :	RS-232 transmitting when on
SIGNAL GREEN LED :	RS-422 receiving when on

NOTE: When power only is supplied to the unit, the green LED may be on as the RX input lines are floating.

Power Supply

The **XP422-9A/I** requires an external power supply for proper operation. We suggest our PS9J 9 Vdc 400 ma power supply. Power must be in the voltage range 7.5 Vdc to 24.0 Vdc.

Integrity Instruments XP422-9A/I User Manual

Jumpers

There is a DTE/DCE jumper associated with the **XP422-9A/I** unit. The DTE/DCE jumpers are inside the unit. **Factory default is DTE.**

If DCE wiring is needed the case will have to be opened. Use a small screwdriver in the slots on the side of the case and twist, this will open the case so the jumpers can be changed. When the jumpers are changed re-assemble the case by squeezing the case pieces together..

JUMPER PHYSICAL POSITION AND ORIENTATION

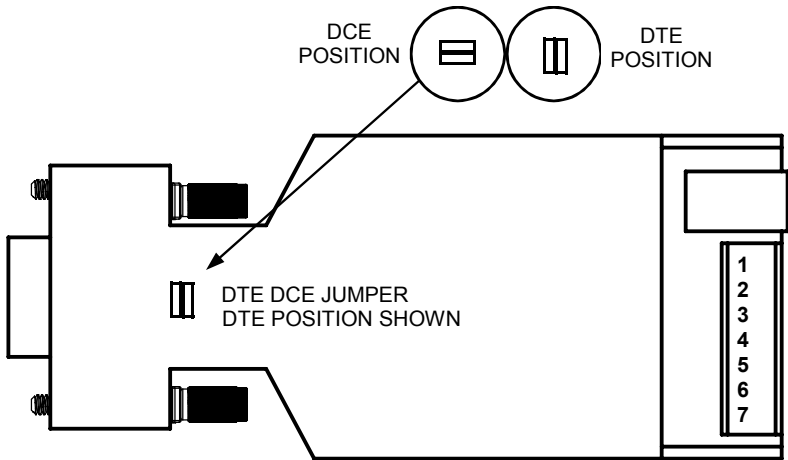

Termination schematic wiring connection

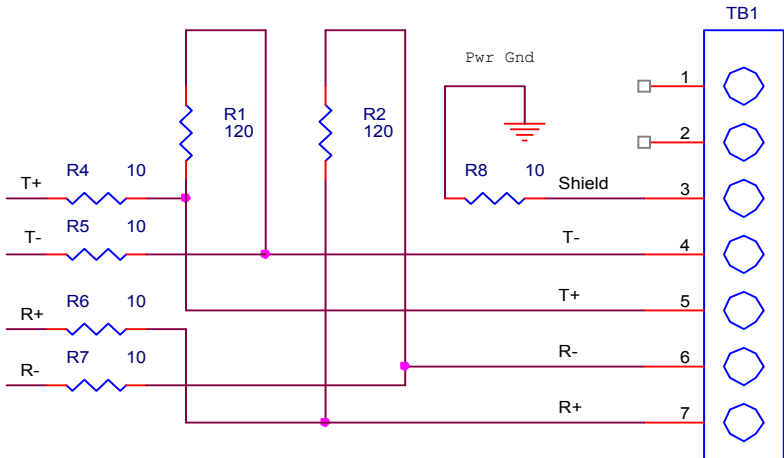

Integrity Instruments XP422-9A/I User Manual

RS-422 Cabling

The **XP422-9A/I** is designed to operate in a point to point configuration. In a full-duplex configuration a separate pair of data lines are used for the transmit data, and the receive data. The connection for the transmit and receive wiring, as well as the power wiring is shown in the diagram below.

XP422-9A and XP422-9I full-duplex cable diagram

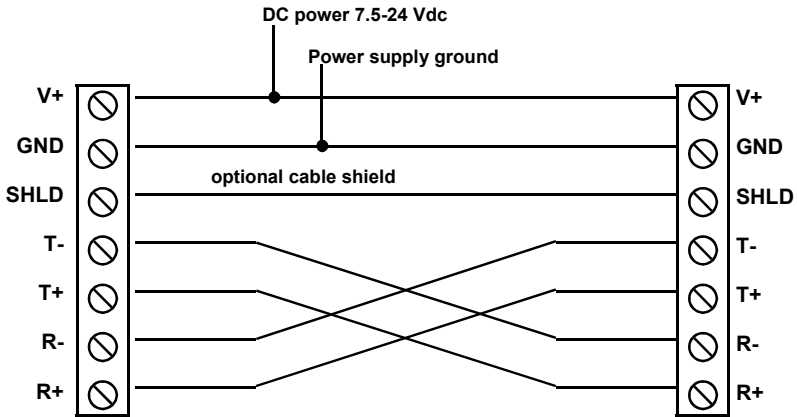

UNIT CAN BE POWERED VIA TERMINAL CONNECTIONS, OR POWER JACK. IF POWERED BY POWER JACK, OTHER UNITS CAN BE POWERED VIA THE TERMINALS

Power 2.5mm horizontal

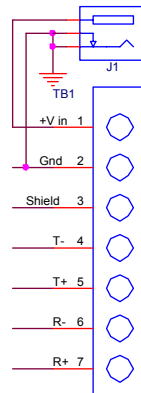

Terminal Block 3.5 mm

Cabling Notes:

- 1) Gnd and Shld are connected internally within the unit thru a 10 ohm resistor.
- 2) Cable termination is important for long distance and high-speed applications
- 3) Suggested cable: 24 awg stranded twisted pair with shield for cable runs in excess of 200 feet. See also Belden cable #9730, #8163, #9830, and #9686.
- 4) Note that the transmit and receive wires are cross coupled.

Integrity Instruments XP422-9A/I User Manual

Flow Control Options

The Microsoft Windows operating systems allow a user to select several RS-232 flow control options. The **XP422-25A/I** supports both **Hardware** and **None** options. The Xon/Xoff flow control is supported only if your RS-422 target device supports Xon/Xoff.

Hardware flow control is also known as RTS/CTS flow control. The PC asserts the RTS (Ready To Send) signal and waits for the connected device to assert CTS (Clear To Send) before transmitting any RS-232 data. The unit reflects the RTS line back to the CTS line in the RS-232 device it is connected to.

None flow control setting is also supported.

Regardless of the flow control method selected, the **XP422-9A/I** will automatically handle the RS-232 transmit and receive signals.

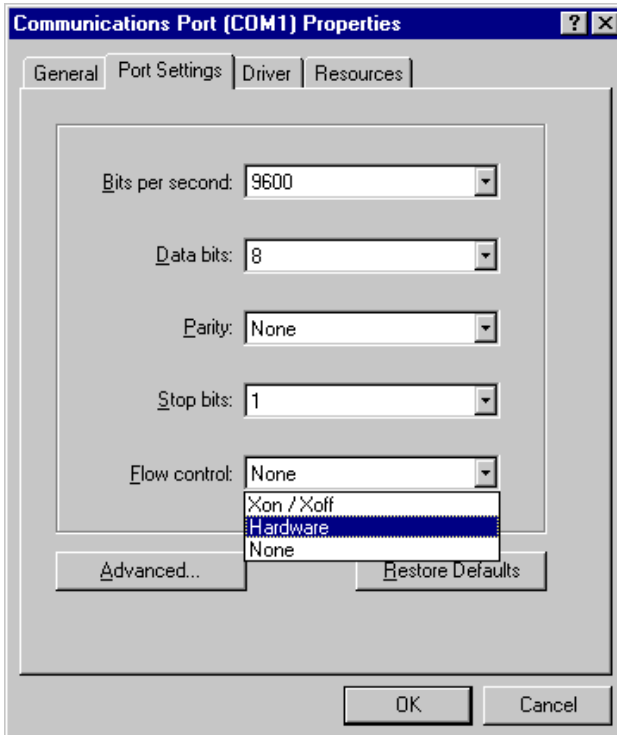

XP422-9A Schematic

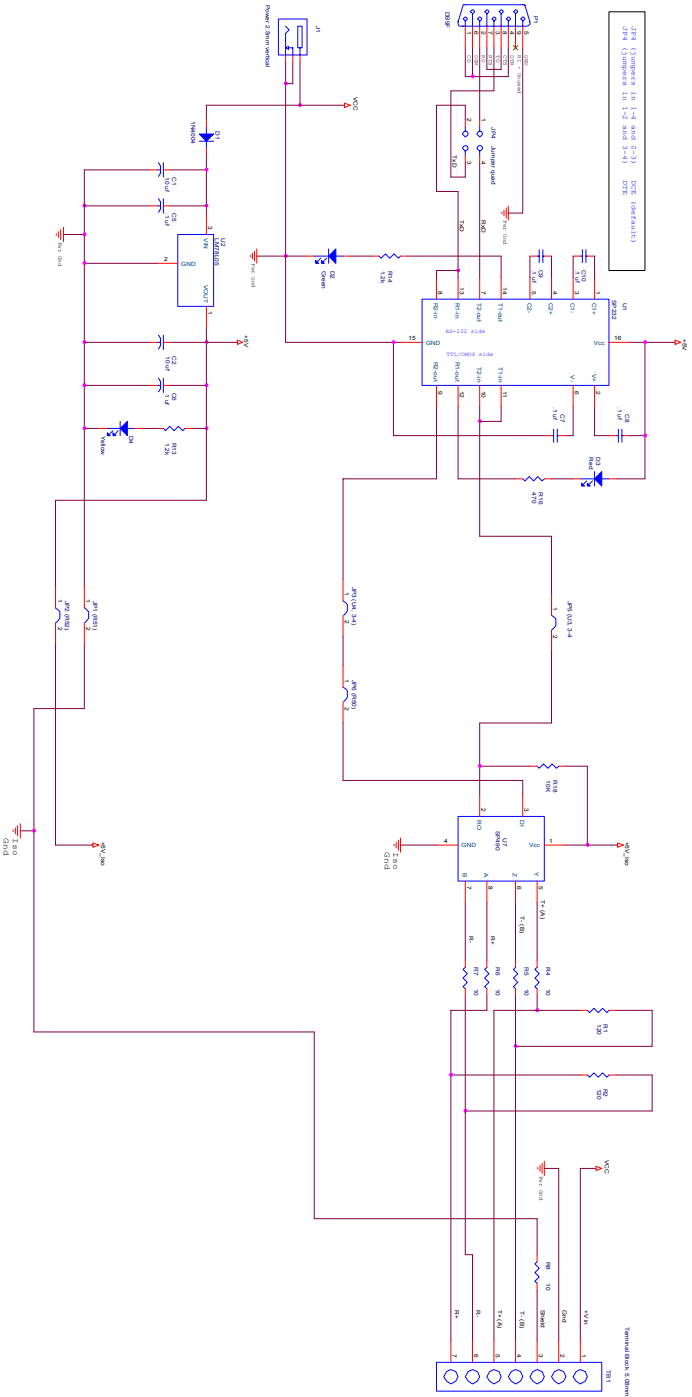

Integrity Instruments XP422-9A/I User Manual

NOTES

WARRANTY

Integrity Instruments warranties **all** products against defective workmanship and components for the life of the unit. Integrity Instruments agrees to repair or replace, at its sole discretion, a defective product if returned to Integrity Instruments with proof of purchase. Products that have been mis-used, improperly applied, or subject to adverse operating conditions fall beyond the realm of defective workmanship and are not covered by this warranty.

Copyright © 2000-2002, Integrity Instruments

All trademarks and/or registered trademarks are the property of their respective owners.