

Integrity Instruments

P.O. Box 451
Pine River Minnesota
56474 USA

Order Phone 800-450-2001
Fax Phone 218-587-3414
Tech Phone 218-587-3120

<http://www.integrityusa.com>

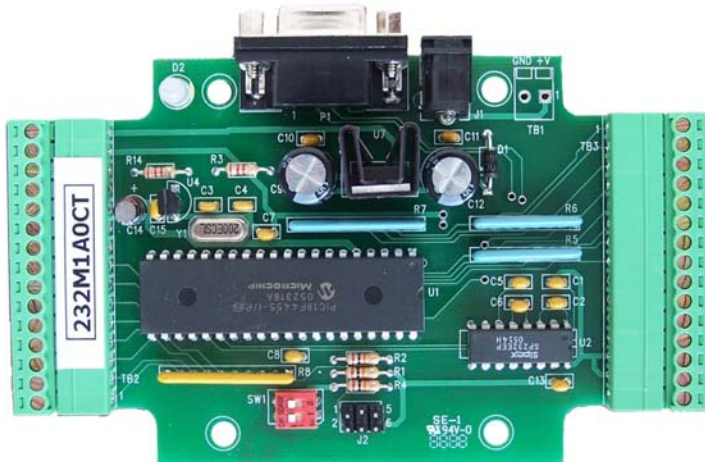

232M100 Series I/O Modules

Digital I/O
Analog I/O

Table of Contents

Introduction

Features.....3
 Quick Start4

Communications

RS-232 Packet Information6

Commands and Responses

Command and Response Table7
 Command and Response Examples8
 Analog Control Nibble.....9

Module Configuration

EEPROM Map10
 EEPROM Map11

Sampling rates

Analog and digital12

Modes of Operation

Polled Mode12
 Asynchronous Update Mode12
 Continuous stream Mode.....13
 Continuous stream Mode Configuration EEPROM Map.....14
 Continuous stream Mode Example.....15

Digital I/O Technical Information

Digital I/O Characteristics16
 Digital I/O Port Configuration Example16
 PWM Characteristics17
 PWM Commands.....17

Analog I/O Technical Information

Analog I/O Characteristics18
 Voltage References18
 Analog Voltage Sampling18
 Analog Conversion19
 Analog Offset Calibration19
 Analog Current Sampling20
 Analog Current Conversion20

Digital & Analog I/O Port Specifications

Digital & Analog pin outs.....21

Module Specifications

PCB Illustrations22
 Dip switch and jumper settings22
 232M300 Series Module Specifications.....23
 232 cabling and specifications23

Peripherals

Analog Connection Board24
 Signal Conditioner Board24
 DB15/DB25 Terminal Strip Board24
 Digital Interface Board24

Integrity Instruments 232M100 Series User Manual

Introduction

Welcome to the Integrity Instruments **232M100 Series** of I/O modules. These modules using RS-232 communications are available in an enclosure, or open allowing you the end user complete flexibility when determining the parameters for your project.

Configurations for 232M100 series model are:

232M1A0CE	8 digital I/O and 8 channels A/D conversion With enclosure
232M1A0CT	8 digital I/O and 8 channels A/D conversion No enclosure

I/O Module features:

MPU:	Microchip PIC18F4455
MPU Clock:	32 Mhz
Interface:	RS-232 (single ended)
Baud:	9600, 19200, 57600, 115200 (DIP switch selectable)
LED:	Bicolor diagnostic LED
Watchdog:	MPU has built-in watchdog timer
POR:	MPU contains timed Power On Reset circuitry
Brownout:	MPU brownout detection circuitry built-in
Temperature:	0° to 70°C (32° to 158°F) <i>Commercial Temperature Range</i>
PCB:	FR4
Power:	7.5Vdc to 15.0 Vdc (approx. 50 ma nominal current) 24 Vdc maximum 100 ma current draw.

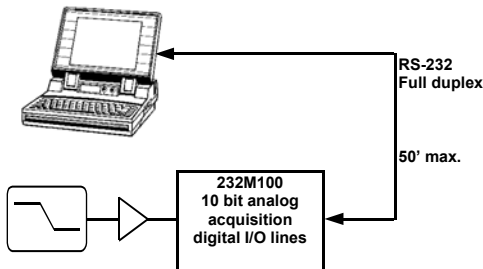

232M100 Series Features

- 8 Digital I/O lines
- 8 10 bit Analog Inputs
- PWM Output
- 32 bit Pulse Counter 1 Mhz

Quick Start Instructions

You need the following:

- EZTerminal program available **free** on our website <http://www.integrityusa.com>
- An open COMPORT on your PC
- Power supply PS9J (9VDC 400 ma unregulated)
- A cable to connect your PC (C9F9M-6 6 foot serial cable)

Make these DIP switch settings for 115,200 baud

SW1: ON

SW2: ON (These are **factory default** settings, see page 21)

Launch the EZTerminal program

1. Double click the icon in whatever area you have put the program.
2. Under “**Settings**” then choose Comport and select your RS-232 port, 115,200 Baud Rate, 8 Data Bits, NO PARITY, and 1 Stop Bits.
3. Under “**Settings**” now choose “**Terminal Settings**”, and check the “**Append LF to incoming CR**” box, and “**Local echo typed characters**” check box.
4. You may change the color of the transmitted and received characters by going under “**Settings**” and selecting “**Colors**” then “**Transmit**” or “**Receive**” and pick the color of your choice.

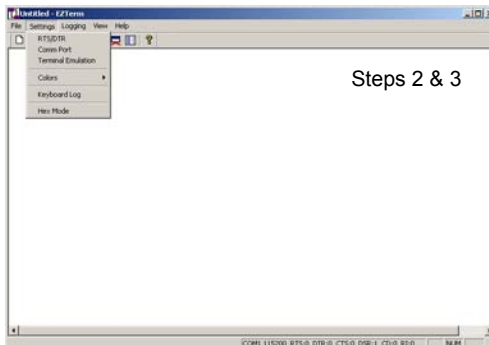
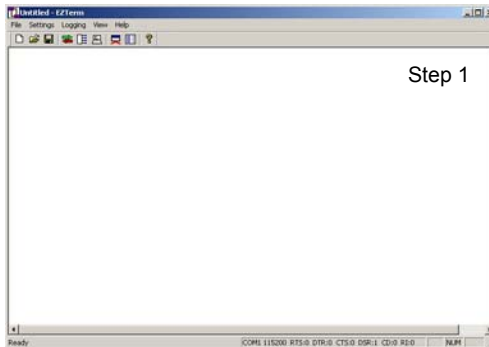

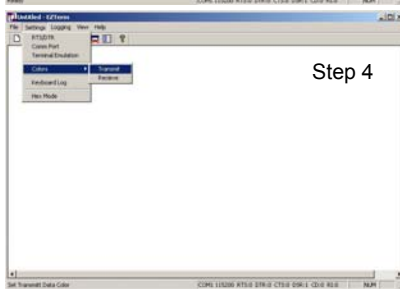
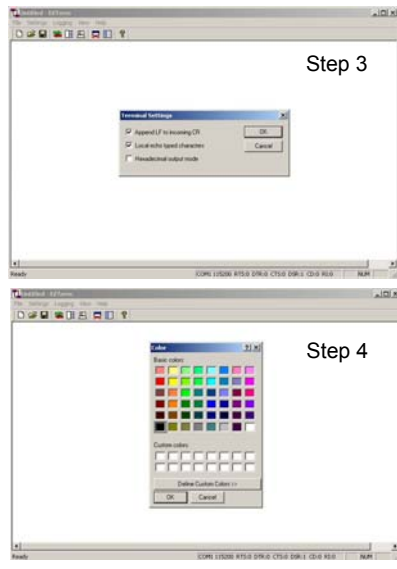
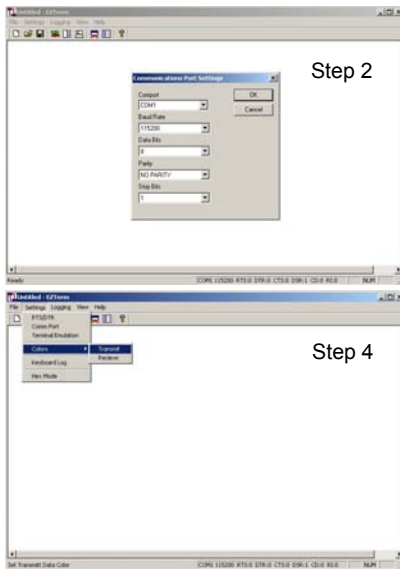

Your First Command

Now that you have a EZTerminal session running, you're ready to power up the **232M100 Series I/O Module**. After powering up your **232M100 Series Module**, EZTerminal will receive a welcome message from the unit indicating you are ready to provide your first command.

RS-232 Firmware Version 3.1 Command:

- Type the letter **V** and the **Enter Key**
- You should see V30 on the screen
- **NOTE:** Make sure to type **CAPITAL V**, not lowercase v!

After your first command, see **Commands and Responses** section for more commands.

Screenshots and setup instructions performed running EZTerminal on a PC installed with Microsoft® Windows® XP Operating System.

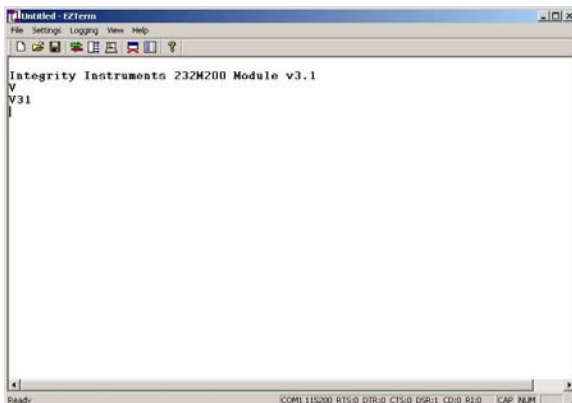

Communications

The Integrity Instruments **232M100 Series** I/O Modules support RS-232 communications interface using simple **ASCII** commands. A carriage return (**decimal code 13 or Hex code 0x0D**) marks the end of each command. Line feeds (**decimal code 10 or Hex code 0x0A**) are ignored.

RS-232 Interface:

- RS-232 operates Full Duplex
- RS-232 modules can also enter **Continuous Stream Mode** whereby the module is configured via EEPROM settings to continuously send data to output its current Digital, Counter or Analog readings.

RS-232 Command Format

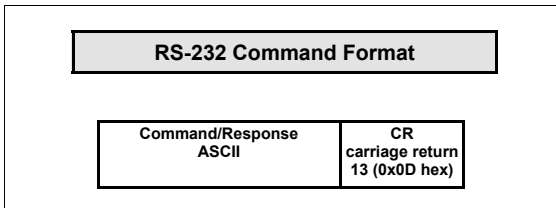

NOTE

- All numeric data is represent as **ASCII Hexadecimal integers** (values **x/y** in the Command and Response table)
- If a module receives an illegal or improperly formatted command, Error Response is sent.
- All ASCII characters are **CASE SENSITIVE** (use all capital letters!)

Integrity Instruments 232M100 Series User Manual

Commands and Responses v3.0 Firmware

Command Sent by Host	Response Sent by I/O Module	Description
V	Vxy	Firmware version x.y
I	Ixxyy	Input digital port status xx = 00 yy = PORT2 Also returns current output port status
Oxxyy	O	Output digital port: xx = (ignored) yy = PORT2
Txxyy	T	Set digital direction: xx = (ignored) yy = PORT2 bit set(1) = Input, bit clear(0) = Output
G	Gxxyy	Get current digital direction: xx = 00 yy = PORT2 bit set(1) = Input, bit clear(0) = Output
N	Nxxxxxxxx	Get Pulse Counter (xxxxxxxx 32 bit counter value)
M	M	Clear Pulse Counter
Uy	Uyxxx	Unipolar sample analog (y control nibble, xxx analog value)
Lyxxx	L	D/A output (y channel setting 0 or 1, xxx 12 bit D/A output)
K	Kxx	Get receive error count (xx current count)
J	J	Clear receive error count
Pxxyyy	P	PWM (xx = PWM frequency, yyy = PWM duty)
Wyyxx	W	Write EEPROM (yy address, xx value)
Ryy	Rxx	Read EEPROM (yy address in command, xx value in reponse)
S	S	Start continuous stream mode
H	H	Halt continuous stream mode
Z	Z	Reset CPU
	X	Command error response sent by module

Commands and Responses

The following table illustrates actual command and response data for an RS-232 interface.

NOTE:

- All numeric data is represent as ASCII Hexadecimal integers.
- The symbol ↵ equates to a carriage return (decimal 13, hex 0x0D).

Command Sent by Host	Response Sent by I/O	Description
V↵	V40↵	Module Firmware version 3.0
I↵	I000F↵	Input digital port [PORT2 bits 0-3 ON] [PORT2 bits 4-7 OFF] Note: this command also returns the current digital output
O007F↵	O↵	Output digital port [PORT2 bit 7 OFF, bits 0-6 ON]
T0080↵	T↵	Set digital direction [PORT2 bit 7 INPUT, bits 0-6 OUTPUT]
G↵	G0080↵	Get current digital direction [PORT2 bit 7 INPUT, bits 0-6 OUTPUT]
N↵	N0000000F↵	Get pulse counter: Current count = 15
M↵	M↵	Clear pusle counter: Current count = 0
U3↵	U340F↵	Unipolar analog control nibble = 0x3 Analog reading = 0x40F
K↵	K00↵	Current receive errors = 0
J↵	J↵	Clear receive error count: Current receive errors
P4801F↵	P↵	PWM freq = 50499 Hz, PWM duty = 10.6%
W0410↵	W↵	Write EEPROM Address 0x04 with value 0x10
R04↵	R10↵	Read EEPROM Adress 0x04 (value is 0x10)
S↵	S↵ I00FF↵ U800F↵ I00FF↵ U800F↵	START continuous stream mode See Modes of Operation section This example illustrates continuous stream mode configured to continuously update with Input Digital Port command and Query Analog command with control 0x1. The module continues until a command H↵ is received.
H↵	H↵	HALT continuous stream mode
Z↵	Z↵	Reset CPU (forces a watchdog timeout)

Analog Control Nibble and Example

The **232M100 Series** I/O modules equipped with analog inputs utilizes the internal analog to digital conversion in the processor chip. In the process of performing a data sample, the user sends a control nibble to the **232M100 Series** module. The **232M100 Series** module in turn performs a data conversion using the control nibble and transmits a response data sample back. The following table lists each of the 8 possible analog configurations.

NOTE

- All numeric data is represent as ASCII Hexadecimal integers
- The symbol ↵ equates to a carriage return (decimal 13, hex 0x0D)
- See **Analog I/O Technical Information** section for sample to volts conversion

Control Nibble	Analog Sample
0	Single Point: CH0
1	Single Point: CH1
2	Single Point: CH2
3	Single Point: CH3
4	Single Point: CH4
5	Single Point: CH5
6	Single Point: CH6
7	Single Point: CH7

Command Sent by Host	Response Sent by I/O Module	Description
U2 ↵	U2123 ↵	Unipolar sample CH2 (Control = 2) Analog sample = 0x123 (decimal 291)
U6 ↵	U6123 ↵	Unipolar sample CH6 (Control = 2) Analog sample = 0x123 (decimal 291)

EEPROM Map:

Address	Description
0x00	N/A - Reserved
0x01	N/A - Reserved
0x02	N/A - Reserved
0x03	Data Direction Port 2 Bit set (1) = Input Bit clear (0) = Output [factory default = 0xFF]
0x04/0x05	Asynchronous Update Mode Configuration 0x0000= No asynchronous updates 0x0001= Change Update on Digital Input or Counter change 0x0002...0xFFFF = Timed Update (Time = Value * 1 milliseconds) 16 bits - upper byte in 0x04 lower byte in 0x05 [factory default = 0x0000]
0x06	N/A - Reserved
0x07	Port 2 Power on Default output [factory default = 0x00]
0x08 See Note 1	Expander board flag (Opto-22 [®] modules attached) 0x00 = No expander board attached 0xFF = Expander board attached (invert digital signals) [factory default = 0x00]
0x09 to 0x0E	N/A - Reserved

WARNING!

The I/O Module CPU must be reset before new EEPROM settings take effect.

NOTE:

1. This flag is used when an expander board is attached. It allows for polarity interface to the industry standard I/O modules used with the expander board based on open collector logic that these modules use.
2. This is used to slow the A/D Channel sample clock rate. This may help when the A/D channels have a high impedance input attached.

EEPROM Map:

Address	Description
0x0F	N/A - Reserved
0x10	Continuous Stream Analog configuration count 0x00 = No analog stream readings 0x01... 0x08 = Number of analog queries [factory default = 0x00]
	See Modes of Operation Continuous Stream for locations 0x11...0x1A
0x11	Analog Query 1 - control byte - analog control nibble
0x12	Analog Query 2 - control byte - analog control nibble
0x13	Analog Query 3 - control byte - analog control nibble
0x14	Analog Query 4 - control byte - analog control nibble
0x15	Analog Query 5 - control byte - analog control nibble
0x16	Analog Query 6 - control byte - analog control nibble
0x17	Analog Query 7 - control byte - analog control nibble
0x18	Analog Query 8 - control byte - analog control nibble
0x19	Continuous Stream Digital Input configuration 0x00 = Digital Input status OFF 0xFF= Digital Input status ON [factory default = 0x00]
0x1A	Continuous Stream Pulse Counter configuration 0x00 = Pulse Counter status OFF 0xFF = Pulse Counter status ON [factory default = 0x00]
0x1B to 0x3A	N/A - Reserved calibration DO NOT TOUCH
0x3B to 0xFF	Available to User

Analog & Digital I/O Sampling Rates

Analog I/O		
Baud Rate	Polled Mode	Continuous Mode
115,200	777	1515
57,600	412	847
19,200	143	310
9600	72	157
Digital I/O		
Baud Rate	Polled Mode	Continuous Mode
115,200	878	1884
57,600	456	960
19,200	156	319
9600	78	159

Sampling rates are in samples per second for a single analog channel or 8 bit digital I/O port tested on Windows 2000 850 Mhz P3 with A/D clock running at full speed. Samples per channel = Sample rate ÷ number of channels being sampled.

Modes of Operation:

The Integrity Instruments I/O modules can operate in three operation modes:

- 1) Polled
- 2) Asynchronous Update
- 3) Continuous Stream.

These modes of operation can be used singularly or together in combination.

#1) Polled Mode

By far, the Polled Mode is the most common usage of the **232M100 Series** I/O modules. In this mode the Host computer sends a command to the I/O Modules which in turn sends an associated response back to the Host computer.

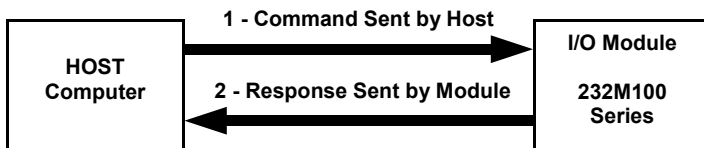

#2) Asynchronous Update Mode

The I/O Module sends data **without** the Host sending a command to poll the I/O Module in Asynchronous Update Mode.

NOTE: Asynchronous Update Mode is configured using EEPROM locations 0x04/0x05.

Value at EEPROM Location 0x04/0x05	Description
0x0000	Asynchronous Update Mode disabled
0x0001	State Change Update Digital Input or Pulse Counter change
0x0002 to 0xFFFF Decimal Range 2 to 65535)	Timed Update Time = Value * 1 millisecond Range = .002 second - 65.5 seconds

#2a) Asynchronous Update Mode — State Change Update

When EEPROM locations 0x04/0x05 = 0x01, the **232M100 Series** I/O module enters an asynchronous update mode whereby any detected change on the Digital Input port or the Counter Capture port causes the I/O module to transmit data to the host.

Status Change	Data Sent by I/O Module
Digital Input port change	Ixxxx
Counter Capture change	Nxxxx



#2b) Asynchronous Update Mode — Timed Update

When EEPROM locations 0x04/0x05 = 0x0002...0xFFFF, the **232M100 Series** I/O module enters a timed update mode whereby the I/O module will send data to the host after the specified time period has elapsed.

Time Period = Value (EEPROM locations 0x04/0x05) * .001 second

When using Asynchronous Update Mode, the I/O module uses the **Continuous Stream Mode** configuration to determine the data sent to the host.

#3) Continuous Stream Mode

The final mode of operation is Continuous Stream mode. This mode constantly sends or **streams** data to the host until the host halts the mode. In brief, the I/O Module can send 0 thru 8 analog samples, digital input status, and the counter capture status.

The I/O module uses parameters found in EEPROM locations 0x10 thru 0x1A to configure the Continuous Stream mode. Therefore, the EEPROM must be configured before engaging the Continuous Stream mode.

Continuous Stream Mode setup steps

1. Configure EEPROM locations 0x10 thru 0x1A
2. Begin Continuous Stream mode by sending command 'S' to the I/O Module
3. Halt Continuous Stream mode by sending command 'H' to the I/O Module

Continuous Stream Mode Configuration — EEPROM Locations

All parameters configuring the Continuous Stream mode are stored in EEPROM. See the following table for a description of the locations and the parameters. Use command 'W' to update EEPROM values.

EEPROM	Value	Description
0x10	0x00...0x08	Analog Configuration 0x00 = No analog samples 0x01...0x08 = Number of analog samples
0x11 <i>Sample 1</i>	0x8y ... 0x8y	Unipolar Analog: y = analog control nibble
0x12 <i>Sample 2</i>	0x8y ... 0x8y	Unipolar Analog: y = analog control nibble
0x13 <i>Sample 3</i>	0x8y ... 0x8y	Unipolar Analog: y = analog control nibble
0x14 <i>Sample 4</i>	0x8y ... 0x8y	Unipolar Analog: y = analog control nibble
0x15 <i>Sample 5</i>	0x8y ... 0x8y	Unipolar Analog: y = analog control nibble
0x16 <i>Sample 6</i>	0x8y ... 0x8y	Unipolar Analog: y = analog control nibble
0x17 <i>Sample 7</i>	0x8y ... 0x8y	Unipolar Analog: y = analog control nibble
0x18 <i>Sample 8</i>	0x8y ... 0x8y	Unipolar Analog: y = analog control nibble
0x19	0x00 0xFF	Digital Input status disabled Digital Input status enabled
0x1A	0x00 0xFF	Pulse Counter status disabled Pulse Counter status enabled

Continuous Stream Mode Example

In this example, the I/O module EEPROM is configured to take 3 Analog samples and update the Counter status.

EEPROM Location 0x10	0x03	<i>Take 2 Analog samples</i>
EEPROM Location 0x11	0x82	<i>Sample 1 - Unipolar sample CH2</i>
EEPROM Location 0x12	0x85	<i>Sample 2 - Unipolar sample CH5</i>
EEPROM Location 0x13	0x87	<i>Sample 3 - Unipolar sample CH7</i>
EEPROM Location 0x1A	0x01	<i>Pulse Counter Status enabled</i>

Continuous Stream Mode Example continued

The following table illustrates the Host Command and I/O Module responses for the continuous stream example configuration and usage.

EEPROM Location 0x10	0x03	<i>Take 2 Analog samples</i>
EEPROM Location 0x11	0x82	<i>Sample 1 - Unipolar sample CH2</i>
EEPROM Location 0x12	0x85	<i>Sample 2 - Unipolar sample CH5</i>
EEPROM Location 0x13	0x87	<i>Sample 3 - Unipolar sample CH7</i>
EEPROM Location 0x1A	0x01	<i>Pulse Counter Status enabled</i>

NOTE

- All numeric data is represent as ASCII Hexadecimal integers
- The symbol ↵ equates to a carriage return (decimal 13, hex 0x0D)

Host Sends	I/O Module Sends
W1003↵	W↵
W1182↵	W↵
W1285↵	W↵
W1287↵	W↵
W1A01↵	W↵
S↵	S↵ <i>Continuous Stream mode started</i>
	U2023 ↵
	U5823 ↵
	U5823 ↵
	N0000 0044 ↵
	U2023 ↵
	U5823 ↵
	U5823 ↵
	N0000 0044 ↵
 repeats continually
H↵	H↵ <i>Continuous Stream mode halted</i>

The HOST may send any command during the Continuous Stream mode and it will be accepted and processed by the I/O Module as in normal operation.

NOTE

Engaging the Continuous Stream mode at a high baud rate (115.2K baud) may overwhelm certain host computer systems due to the high volume of data transmitted on the RS-232 link. This is especially true of slower 386 or 486 based systems running Windows 95 with limited memory resources.

Digital I/O Characteristics

The following chart lists the Digital I/O characteristics and values.

Characteristic	Value
Digital I/O Current	I/O line source & sink 25 ma Total current PORT2 200 ma
Digital I/O Voltage Levels	Input Off (0) = 0V - 0.8V Input On (1) = 2.0V - 5.0V Output Off (0) = 0.6V max. Output On (1) = 4.3V min.
Pulse Counter Input	1 Mhz max. input rate 32 bit counter capture Counter increments on high-low transition

Digital Port Configuration Example

Any Digital I/O configuration changes made to the I/O Module using the 'T' command are stored in EEPROM location 0x03.

EEPROM Location 0x03 Port 2 I/O Configuration

When using either the 'T' command or directly writing to EEPROM using the 'W' command, a binary 1 at a bit location puts the I/O line into Input mode, while a binary 0 at a bit location puts the I/O line into Output mode.

NOTE

- All numeric data is represent as ASCII Hexadecimal integers
- The symbol ↵ equates to a carriage return (decimal 13, hex 0x0D)

Host Command	Module Response	Action
T0000↵	T↵	All I/O lines are configured as Outputs
T00FF↵	T↵	All I/O lines are configured as Inputs
T000F↵	T↵	Port 2 bits 0-3 Inputs Port 2 bits 4-7 Outputs
T00F0↵	T↵	Port 2 bits 0-3 Outputs Port 2 bits 4-7 inputs
T0034↵	T↵	Port 2 bits 4,5,2 Inputs Port 2 bits 7,6,3,1,0 Outputs

Pulse Width Modulation (PWM) Characteristics

The **232M100 Series** modules have a configurable PWM output. There are two settings to configure for proper PWM operation: **PWM frequency** and **PWM duty cycle**.

PWM — Command

Pxyyyy xx = Pwm_Divisor yyy = Pwm_Duty (10 bits max.)

Pwm_Divisor = 0x00 ... 0xFF

Pwm_Duty = 0x000 ... 0x3FF **Pwm_Duty = 0, PWM output is disabled (output 0)**

PWM — Control Values (32 Mhz clock)

PWM Period = (Pwm_Divisor + 1) / 8,000,000

PWM Duty Period = (Pwm_Duty) / 32,000,000

Duty_Resolution = log (32,000,000/ Fpwm) / log (2)

PWM Duty Cycle % = PWM Duty Period / PWM Period

if (PWM Duty Period > PWM Period) then PWM Duty Cycle = 100%

Pwm_Divisor	PWM Freq	Duty_Resolution
0xFF (255)	31,250 Hz	10 bits* (see note)
0xFE (254)	31,373 Hz	10 bits
0x5B (91)	86,957 Hz	8 bits
0x00 (0)	8,000,000 Hz	2 bits

* **Note:** Pwm_Divisor 0xFF cannot achieve complete 100% duty cycle. Use Pwm_Divisor 0xFE if 100% duty cycle is required.

Example PWM Commands

- All numeric data is represent as ASCII Hexadecimal integers
- The symbol ↵ equates to a carriage return (decimal 13, hex 0x0D)

Host Command	Module Response	Action
P0000↵	P↵	PWM off Any duty cycle of 0 disables PWM output
P4801F↵	P↵	PWM frequency = 109,599 Hz PWM duty = 10.6%
PFE3FF↵	P↵	PWM frequency = 31,327 Hz PWM duty = 100%
PFE1FE↵	P↵	PWM frequency = 31,327 Hz PWM duty = 50%

Analog I/O Characteristics:

Characteristic	Value
A/D Converter	0 to 10 Volt input
Linearity Error	$<\pm 1$ LSB
Gain Error	$<\pm 1$ LSB
Offset Error	$<\pm 1.5$ LSB
Max Input Voltage	10V

Analog Operation

The analog inputs look like a 100pf capacitor (Cin) in series with a 560 Ω resistor (Ron). Cin gets switched between (+) and (-) inputs once during each conversion cycle. Large external source resistors and capacitances will slow the settling of the inputs. It is important that the overall RC time constant is short enough to allow the analog inputs to settle completely within the allowed time.

The voltage on the inputs must settle completely within the sample period. Minimizing Rsource will improve the settling time.

Sampling Analog Voltage Inputs

By far the most common configuration of the **232M100 Series** I/O modules is to sample voltage values. Analog voltage levels are converted to integer digital values. The input voltage range is determined by the reference voltage.

There is only one analog sample type:

1) Unipolar

Sampling type results in a 10 bit binary integer value.

Vref = 5.000 standard

Unipolar Analog Sampling Resolution

Unipolar analog sampling span is from ground (GND) to voltage reference (Vref). **Only positive voltages are sampled in unipolar mode.** The unipolar sample is represented as an unsigned integer as follows:

Unipolar voltages: 0V ... +Vref

1 LSB unipolar = $V_{ref}/1024$

1 LSB unipolar = $5.000/1023$

But there is a voltage divider on the inputs dividing the input equally

Vref effectively = 10

1 LSB unipolar = $(5.000/1023) \times 2$

1 LSB unipolar = 0.0097751

Voltage Conversion

The Analog conversion value obtained from the **232M100 Series** module is represented as an integer value unsigned for Unipolar sample and is normally converted to a Real or Floating Point number for ultimate usage.

Vref = 5.000 standard

Unipolar Voltage Conversion Formula

Volts [unipolar] = ADC_Sample * (5.000/4096)

Volts [unipolar] = ADC_Sample * 0.0012207

Obtaining accurate Analog samples

Please keep the following points in mind when attempting to obtain accurate samples.

- Avoid high impedance analog signal sources!
- Watch out for UPS systems! They create loads of EMI/EMF noise.
- Keep the analog signal source as close to the ADC-x module as possible.
- Keep transformers far away from the **232M100 Series** module.
- Use good wiring practices, especially in regards to ground connections.
- RS-232 interface can generate approx. 2 mv noise.

Hex Conversion Chart

EXAMPLE HEX CONVERSION																
X				X				Y				Y				
BITS	1	1	0	0	1	0	0	0	1	0	1	1	0	1	1	1
HEX	C				8				B				7			

PORT 1								PORT 2											
X				X				Y				Y							
HEX VALUE	BIT VALUE			HEX VALUE	BIT VALUE			HEX VALUE	BIT VALUE			HEX VALUE	BIT VALUE						
	7	6	5		4	3	2		1	0	7		6	5	4	3	2	1	0
0	0	0	0	0	0	0	0	0	0	0	0	0	0	0	0	0			
1	0	0	0	1	1	0	0	0	1	1	0	0	0	1	1	0	0	0	1
2	0	0	1	0	2	0	0	1	0	2	0	0	1	0	2	0	0	1	0
3	0	0	1	1	3	0	0	1	1	3	0	0	1	1	3	0	0	1	1
4	0	1	0	0	4	0	1	0	0	4	0	1	0	0	4	0	1	0	0
5	0	1	0	1	5	0	1	0	1	5	0	1	0	1	5	0	1	0	1
6	0	1	1	0	6	0	1	1	0	6	0	1	1	0	6	0	1	1	0
7	0	1	1	1	7	0	1	1	1	7	0	1	1	1	7	0	1	1	1
8	1	0	0	0	8	1	0	0	0	8	1	0	0	0	8	1	0	0	0
9	1	0	0	1	9	1	0	0	1	9	1	0	0	1	9	1	0	0	1
A	1	0	1	0	A	1	0	1	0	A	1	0	1	0	A	1	0	1	0
B	1	0	1	1	B	1	0	1	1	B	1	0	1	1	B	1	0	1	1
C	1	1	0	0	C	1	1	0	0	C	1	1	0	0	C	1	1	0	0
D	1	1	0	1	D	1	1	0	1	D	1	1	0	1	D	1	1	0	1
E	1	1	1	0	E	1	1	1	0	E	1	1	1	0	E	1	1	1	0
F	1	1	1	1	F	1	1	1	1	F	1	1	1	1	F	1	1	1	1

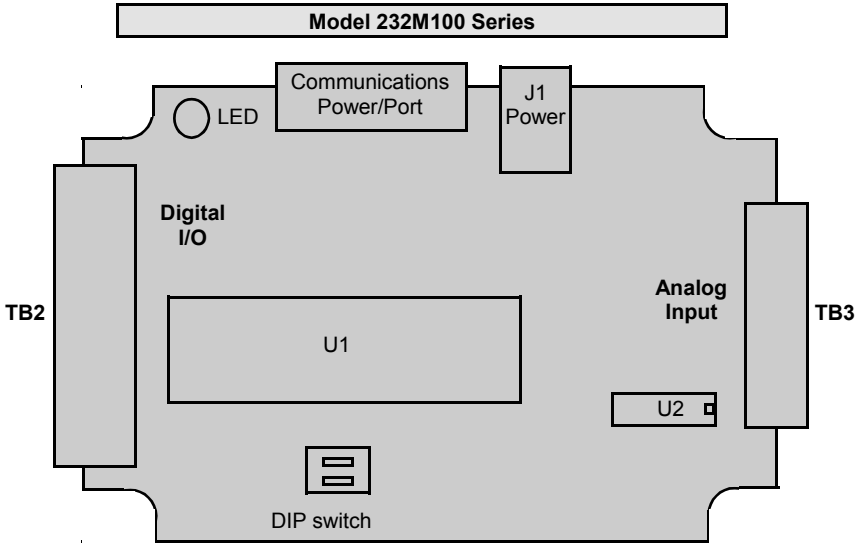

COMMUNICATION PORT ON BOARD WIRING

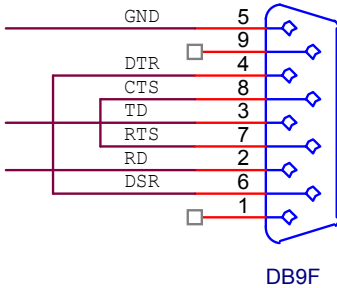

POWER CONNECTIONS ON BOARD WIRING

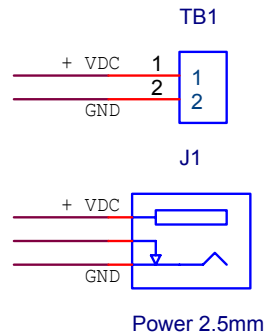

Baud Rate Switch Settings		
SW1	SW2	Baud Rate
OFF	OFF	9600 baud
ON	OFF	19200 baud
OFF	ON	57600 baud
ON	ON	115200 baud (factory default)

IC	232M300 I/O Module
U1	PIC16F874A MPU [40 pin dip]
U3	RS-232 driver [16 pin DIP]

LED Operation

Blinking Green	[1 per Second]	Unit functioning correctly - idle
Blinking Green	[Rapid or Steady]	Unit receiving serial data
Blinking Red	[Rapid or Steady]	Unit transmitting serial data
No LED		Unit is not functioning

Power Supply

7.5-15.0 Vdc approx. 50 ma. nominal power, 24 Vdc maximum 100 ma current draw (we suggest our PS9J a 9VDC 400 ma unregulated power supply)

GND and Shield

The GND and Shield terminals are connected on the **232M300 Series** boards and are therefore electrically equivalent.

RS-232 Cabling

The RS-232 interface uses a "3 wire" RS-232 connection. That is to say only three wires are connected between the I/O Module and the Host PC: **TxD**, **RxD** and **GND**.

RS-232 Flow Control

The Integrity Instruments modules **do not support hardware or Xon/Xoff flow control**.

Peripheral Add-On Modules

The **EXP-X** expander unit provides for digital interface and signal conditioning via industry standard opto-isolated I/O modules such as Opto-22. Each unit has 4 I/O points with large easy to use terminal screws. If more I/O points are required, simply plug in another unit up to 8 total I/O points may be used the **232M100** module.. **Opto isolated modules:** 90V-140V AC input, 12V-140V AC output, 3.3V-32V DC input, 3V-60V DC output.

You will have to use our **DB25TSF** adapter to wire from the terminal strip of the **232M100** unit to the expander module.

WARRANTY

Integrity Instruments warranties **all** products against defective workmanship and components for the life of the unit. Integrity Instruments agrees to repair or replace, at it's sole discretion, a defective product if returned to Integrity Instruments with proof of purchase. Products that have been mis-used, improperly applied, or subject to adverse operating conditions fall beyond the realm of defective workmanship and are not covered by this warranty.

Copyright © 2000-2003, Integrity Instruments, Inc.

All trademarks and/or registered trademarks are the property of their respective owners.

Revision: August 24, 2005 - v3.0